

---

---

# Table of Contents

---

---

<b>Welcome!</b> .....	2	Lockout Tips .....	16
Features .....	4	Restore a Locked Out Frequency .....	17
Types of Communications .....	5	Restore All Locked-Out Frequencies .....	17
<b>Included With Your Scanner</b> .....	6	Search .....	18
<b>Fast Start</b> .....	7	CB Channel Search .....	19
Power ON .....	7	Hold/Resume While Searching .....	19
How Squelch Works .....	8	Data Skip .....	20
Setting the Squelch .....	8	Programming .....	21
Scanning the Alert Monitor Frequency Banks .....	9	Programming Frequencies .....	22
Selecting the State .....	9	Clearing a User-Programmed Frequency .....	23
Selecting a Frequency Bank .....	9	Memory Lock .....	24
Scan Hold .....	10	Memory Back-up .....	24
Warning Alert .....	11	<b>Installation</b> .....	25
Alert Tone Volume .....	11	Mobile Installation .....	25
Muting the Alert Tone .....	12	Connecting the Power .....	26
One Moment Mute .....	12	Base Installation .....	27
Continuous Mute .....	12	<b>Tips and Techniques</b> .....	28
Canceling Mute .....	12	Trunking .....	29
Warning Light Adjustment .....	12	Scanner Care & Maintenance Tips .....	30
Power On Settings .....	13	<b>Troubleshooting</b> .....	31
Priority Channels .....	13	<b>Optional Accessories and Replacement Parts</b> .....	33
Scanning Fire, News, Weather and Private Frequency Banks .....	14	<b>Specifications</b> .....	34
Scan Hold .....	15		
Frequency Lockout .....	15		

---

---

# Welcome!

---

---

Congratulations on your purchase of the **BCT7** Highway Communications System & Scanning Radio! State-of-the-art engineering and advanced electronics provide you with a preprogrammed information radio designed for easy operation and dependability.

With the **BCT7** Scanning Radio, you can listen to thousands of Highway Patrol, police, and DOT frequencies, as well as Fire, News, Weather, CB and Private frequencies you program.

***Plus, the new built-in technology sounds an alarm when you are within an approximate 3 mile radius of a Highway Patrol unit!***

Best of all, you don't have to program any frequencies. Just set the **BCT7** for your state, and the scanner will do the rest. Please read this Operating Guide thoroughly before attempting to operate the unit.

## What are Highway Patrol Warning Alerts?

Most highway patrol vehicles on the road today are equipped with a secondary radio system known as a "mobile extender" or "vehicular repeater." Whenever the dispatcher transmits to any vehicle in the district, every "mobile extender" in every car within the district is activated.

Using a constant PRIORITY check of specific frequencies in each state, the **BCT7** recognizes and alerts you to transmissions from "mobile extender" radios as well as from car-to-car, aircraft-to-car and other special-purpose frequencies. You receive an audible (beep tone) and visual (flash of warning light) alert whenever you are within an approximate three mile radius of many Highway Patrol/State Police units.

## What is Scanning?

Unlike standard AM or FM radio stations, most two-way communications (listed on the page 5) do not transmit continuously. The **BCT7** scans *programmed* channels at the rate of nearly 100 channels per second until it finds an active frequency.

Scanning stops on an active frequency, and remains on that channel as long as the transmission continues. When the transmission ends, the scanning cycle resumes until another transmission is received.

While the **BCT7** scans channels, it is in Scan mode. When you stop scanning with , it is in Manual mode.

## What is Searching?

The **BCT7** can search 12 bands to find active frequencies. This gives you the opportunity to find new frequencies that have not been programmed.

While the **BCT7** searches for active frequencies, it is in Search mode. When you stop the search with , it is in Search Hold mode.

## Where to Get More Information

Because your **BCT7** is fully pre-programmed, you do not need to enter frequencies into the radio. However, should you desire to enter specific frequencies which have not been factory pre-programmed, the **BCT7** provides this capability.

For publications which list frequencies around the United States, call the enclosed Mr. Scanner 800 number.

The Bearcat Radio Club and other similar hobby clubs have publications, information on computer bulletin boards, and even contests for the radio enthusiast. Also, your local library has more information.

## Features

- Pre-programmed frequencies specific to each state (except Hawaii).
- Pre-programming by the following categories:
  - Highway Patrol/State Police
  - Local Police and County Sheriffs
  - State Departments of Transportation (DOT)
  - Fire and Emergency Medical Services
  - News Media
  - Weather (continuous NOAA weather and Canadian Coast Guard broadcasts)
- 100 channels of user-programmable frequencies available
  - Program frequencies into each of the above banks, or
  - Program your own bank of 25 Private frequencies
- Highway Patrol Priority Alert
  - Receive audible and visual alert when within three miles of many Highway Patrol/State units
- CB Search - Search all 40 CB channels
- Band Search - Search through 12 bands of radio spectrum for frequencies.
- 26 MHz - 956 MHz - Scan these frequency ranges with your **BCT7**. (Note: the frequency coverage is not totally continuous.)
- Data Skip - Skip certain data signals and unmodulated transmissions.
- Memory Backup - In case of a power failure, user-programmed frequencies are retained in memory for approximately 30 days.

## Types of Communications

Monitor communications such as:

- Highway Patrol, police and fire department (including paramedics)
- Aircraft
- NOAA weather broadcasts
- Business/industrial radio
- Motion picture and press relay
- Utility
- Land transportation frequencies, such as trucking firms, buses, taxis, tow trucks, and railroads
- Marine and amateur (ham radio) bands
- And many more in the following 12 Bands:

Frequency Range	Transmission
29.0-30.0 MHz	10 Meter Amateur Band
30.0-50.0 MHz	VHF Low band
118-137 MHz	AM Aircraft
137-144 MHz	Military Land mobile
144-148 MHz	2 Meter Amateur Band
148-174 MHz	VHF High Band
406-420 MHz	Federal Govt. Land Mobile
420-450 MHz	70 cm Amateur Band
450-470 MHz	UHF Standard Band
470-512 MHz	UHF "T" Band
806-956 MHz	Public Service Band except Cellular Band
26.965-27.405 MHz	Citizens Band

# Included With Your Scanner

## BearTracker 800 BCT7

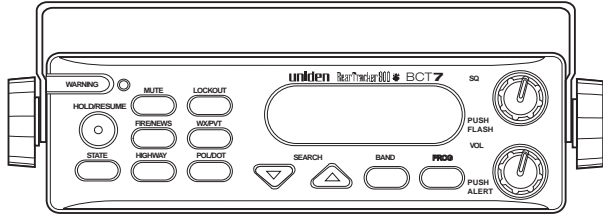

Operating Guide  
(OMBCT7)



Betty Bearcat  
Starter Frequency  
Guide

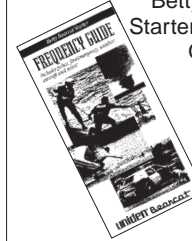

Flexible Mobile Antenna  
(ANT002)

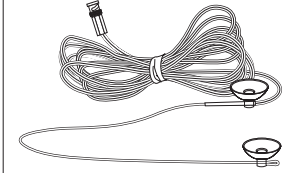

Hard Wire Cord  
(PS001)

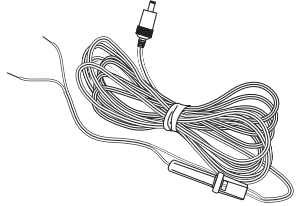

Cigarette Lighter  
Adapter Plug  
(WZ-1244)

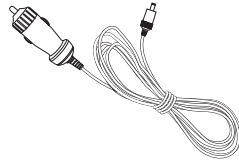

Mobile Mounting Bracket  
Assembly Kit  
(MB007)

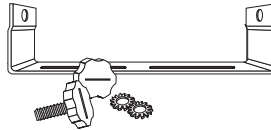

Telescoping Antenna  
(AT124)

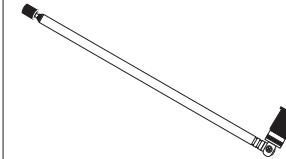

AC Adapter  
(AD140U)

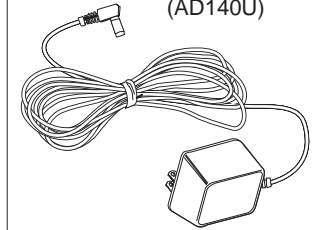

Other Printed  
Material

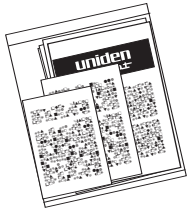

- If any Items are missing or damaged, immediately contact your place of purchase.
- Read this Operating Guide thoroughly before operating the scanner.
- Complete and immediately mail the Registration Form in this Operating Guide.

**Note:** Fold out the illustration from the front cover to see the controls and LCD display while reading this guide.

## Power ON

1. Turn the volume knob clockwise.

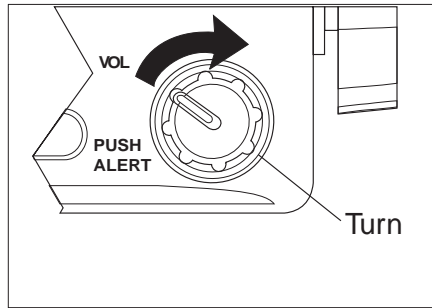

The scanner performs a self-test: the Warning Light flashes and the Alert Tone beeps loudly.

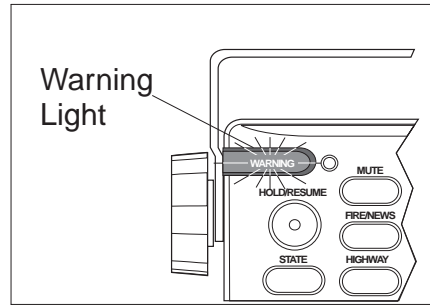

2. The currently selected state (e.g., TX for Texas) appears and scanning starts.



## How Squelch Works

Think of “SQUELCH” as a gate. If the gate is too low (squelch too low), everything (all noise as well as signals) gets through.

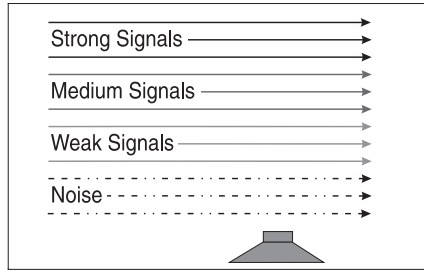

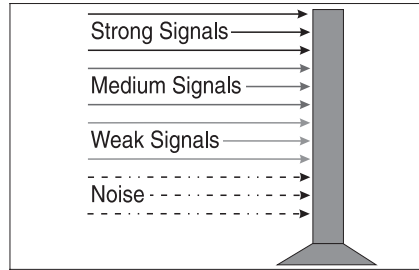

If the gate is set too high (squelch too high), nothing gets through.



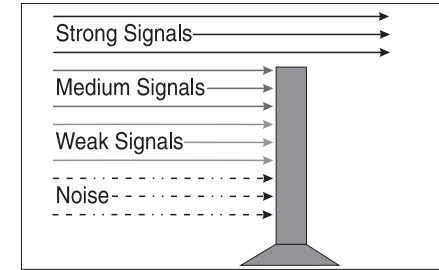

If the gate is set just right (squelch set properly), just the desired signals get through.



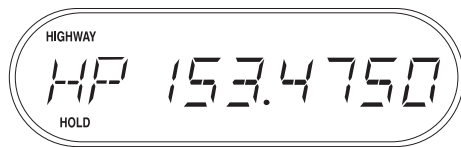

## Setting the Squelch

No signal should be present when setting Squelch.  
Press  to stop scanning.  
If needed, press  or   
until you **do not** hear a signal.

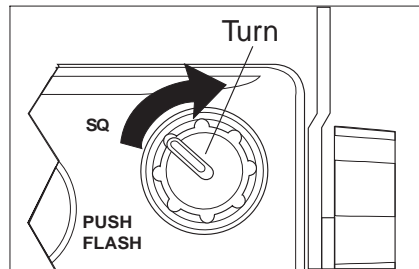

 Turn until hiss heard.  
This lowers the “squelch gate,”  
allowing all signals and noise to get  
through.



 Turn just until hiss stops.  
This raises the “squelch gate,”  
allowing only strong signals to get  
through.

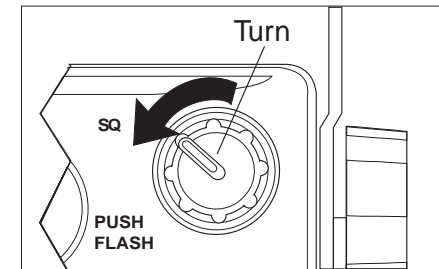

In the city, you may want to adjust Squelch even further counterclockwise to decrease the range of the Warning Alert. This prevents the alert from sounding unnecessarily due to farther, less important sources.



## Scanning the Alert Monitor Frequency Banks

The Alert Monitor works with the Highway Patrol, Police, and Department of Transportation (DOT) frequency banks. Frequencies are preprogrammed at the factory on a state-by-state basis.

### Selecting the State

Press **STATE** to select the state you are operating in. Press and hold **STATE** to scroll rapidly.



To step forward through the states (A - W), press **STATE** and, within two seconds, press **▲** repeatedly. To step backward through the states (W - A), press **STATE** and, within two seconds, press **▼** repeatedly.



To scroll rapidly, press **STATE** and hold **▼** or **▲**.

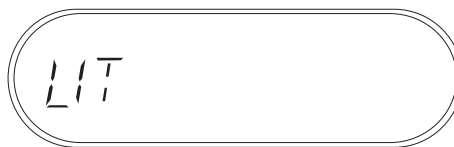
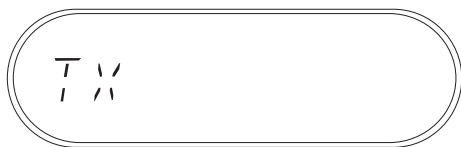

### Selecting a Frequency Bank

Press **HIGHWAY** to monitor Highway Patrol frequencies.



Press **POL/DOT** to monitor Police frequencies.



Press **POL/DOT** again to monitor DOT frequencies.

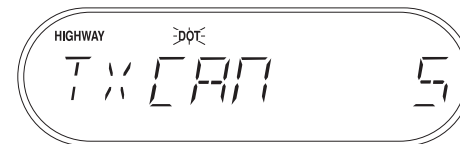
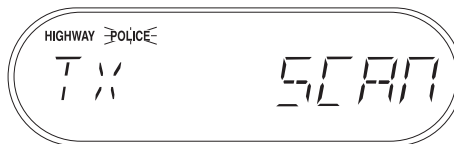
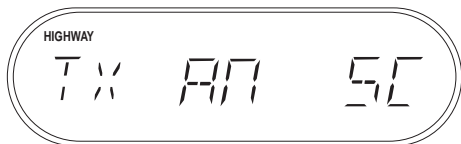

**HIGHWAY** appears in the display and scanning begins two seconds later.

**POLICE** flashes in the display and scanning begins two seconds later. **HIGHWAY** flashes, because those frequencies are scanned, too.

**DOT** flashes in the display and scanning begins two seconds later. **HIGHWAY** flashes because those frequencies are scanned, too.

When the **BCT7** receives communications, scanning stops, the active bank type replaces the state code, and the frequency displays.

Active Bank indicators:  
**HP** - Highway Patrol  
**PO** - Police  
**DT** - DOT

When the transmission ends, a built-in two second delay feature holds the scanner on that frequency for a response. If there is no response, scanning resumes.



## Scan Hold

When scanning stops on a desired frequency, press  to hold on that frequency as long as you like.

To resume scanning, press .

To scan the other frequency banks, see "Scanning the Fire, News, Weather, and Private Frequency Banks," page 14.

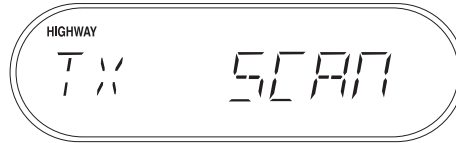

**Note:** While in the *HOLD* mode, the alarm circuit is inactive.

## Warning Alert

The **BCT7** alerts you when Highway Patrol/State Police units using mobile extenders are within an approximate three mile radius.

1. The Warning Light flashes and the Alert Tone beeps five times when a signal is received.



2. The active bank indicator replaces the state name, and the frequency displays until the transmission ends.



3. The Warning Light glows steadily for approximately three minutes. Then, if no other mobile extender transmissions are received, the light goes out.

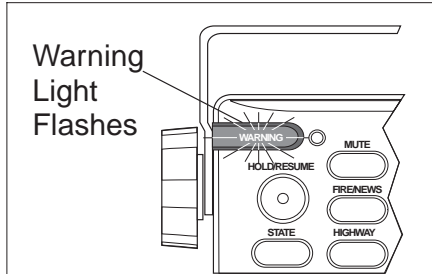

4. If more transmissions are received before three minutes have passed, the Warning Light flashes and the Alert Tone sounds twice.

## **Alert Tone Volume**

Push the **VOLUME** control knob to select Loud, Medium, or Soft.

The Alert Tone beeps to confirm your choice.

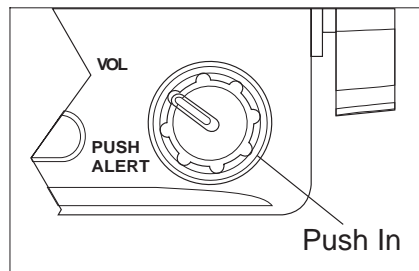

## Muting the Alert Tone

### One Moment Mute

Press **MUTE** during the Warning Alert. The Alert Tone stops and the Mute LED flashes until the alarm cycle is finished.

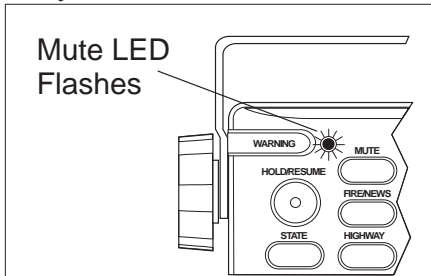

### Continuous Mute



Press and hold **MUTE** for two seconds to turn Continuous Mute on whenever you wish. You hear two beeps and the Mute LED lights continuously. No Alert Tones will sound.



### Canceling Mute

To cancel Mute,

1. Press and hold **MUTE** for two seconds. You hear two beeps and the MUTE LED goes out.
2. Change states or frequency banks. The Mute LED goes out after scanning starts.
3. Turn the scanner off and on.

**Note:** Mute only works in the Highway, Police, and DOT frequency bands.

## Warning Light Adjustment

The Warning Light has three settings: Bright, Dim, and Off.

Press **SQUELCH** to select Bright, Dim or Off. The WARNING light flashes and the alert tone beeps.



If you select OFF, the **FLASH** icon in the display reminds you the Warning Light is off.

**WARNING:** You can turn off the Warning Light and completely mute the Alert Tone at the same time. This deactivates the Warning Alert.

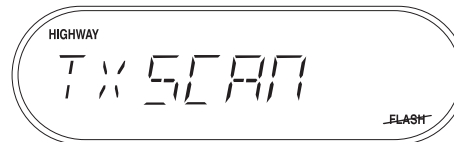
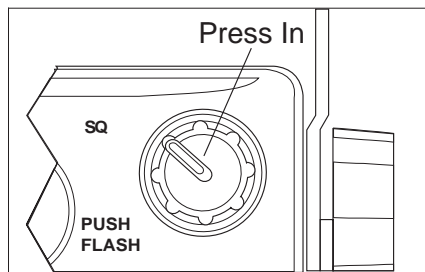

## Power On Settings

When you turn the **BCT7** off and then on again, the **BCT7** will return to the last settings that were active. When you have chosen the state you will be driving in, and the mode (HIGHWAY PATROL, DOT, etc.), the **BCT7** always returns to these settings.

---

## Priority Channels

Each state preprogrammed in the **BCT7** contains a number of Priority channels. The **BCT7** automatically checks a state's Priority channels every two seconds for activity. If there is activity on one of the Priority channels, the warning light will flash and the alarm tone will sound (see "Warning Alert," page 11).

You will experience a slight in the conversations you hear as the **BCT7** checks the Priority channels. You can cancel the priority check and the interruptions in the conversations by pressing the  key to hold on the frequency.

**Note:** *The Warning Alert is inoperative while the scanner is on Hold.*

Remember to press the key again to return to normal priority-scan operation.

Priority cannot be changed, but you can lock-out priority channels using the  key. Priority channels have been pre-determined by the manufacturer as those Highway Patrol frequencies most commonly used for mobile extenders and for car-to-car and aircraft-to-car operations. Mobile extenders re-transmit every radio broadcast received on the patrol car radio to the officer's walkie-talkie at low-power. Every time any officer or dispatcher talks (transmits), the signal is broadcast like a beacon at low-power whether or not the officer is out of the car.

## Scanning Fire, News, Weather, and Private Frequency Banks

**Note:** The Warning Alert does not work while scanning these banks.

To scan Fire frequencies, press .



To scan News frequencies, press  again.



To scan Weather Frequencies, press .

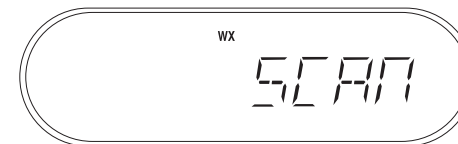
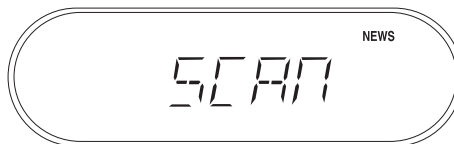
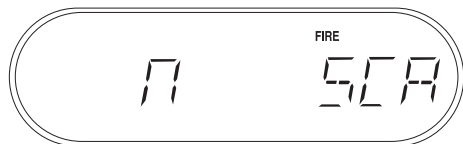

**FIRE** appears in the display and scanning begins two seconds later.

**NEWS** appears in the display and scanning begins two seconds later.

**WX** appears in the display and scanning begins two seconds later.

To scan your Private frequencies you have programmed, press  again.

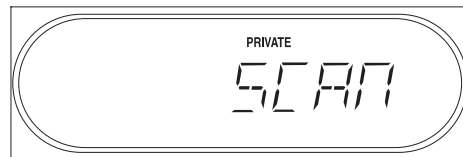

When the **BCT7** receives Fire, News, Weather, or Private frequencies, scanning stops and the active frequency is displayed. The State Code/Active Bank Indicators **do not** appear in these frequency banks.

**PRIVATE** appears in the display and scanning begins two seconds later.

When a transmission is received, the scanner stops on that frequency. When the transmission ends, a built-in two second delay feature holds the scanner on that frequency for a response. If there is no response, scanning resumes.

## Scan Hold

**Note:** *Warning Alert does not work in this mode.*

When scanning stops on a desired frequency, press  to hold on that frequency as long as you like.

To resume scanning, press .

 If the **BCT7** stops on an undesired frequency, press  twice to force the unit to start scanning before the end of that transmission..

Or, lock out that frequency (see Frequency Lock Out)

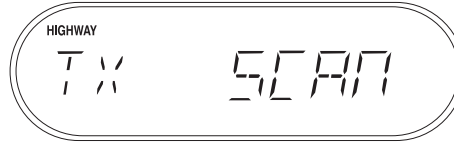

---

## Frequency Lock Out

You can lock out a frequency so it is not scanned.

Lock out does not erase the frequency.

You can restore the frequency to scanning whenever you wish.

**Note:** *You can lock out up to 50 preprogrammed frequencies and 100 user-programmed frequencies.*

### In Scan Mode

When the scanner stops on a frequency you don't want to hear, press .



Scanning resumes immediately because that frequency is no longer in the scanning sequence.

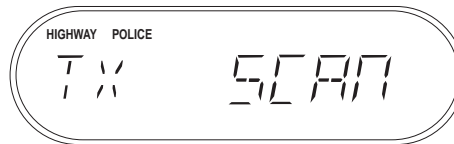
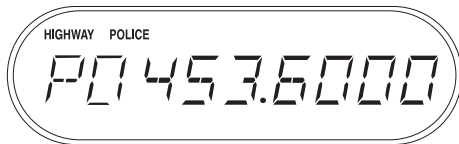

## In Hold Mode

Press .



**LOCKOUT** appears on the display.  
Scanning doesn't resume until you press .

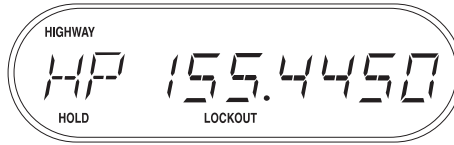







---

## Lockout Tips

- After you have locked out the 50th preprogrammed frequency (or 100th user programmed frequency), you may lock out a new frequency. However, the first frequency you locked out becomes unlocked to make room for the new frequency.
- You can lock out all the frequencies in a bank, if desired. However, if you do, pressing that bank key will emit an error tone and the scanner will not scan.
- If you lock out a preprogrammed frequency in one bank, and that frequency is programmed into another bank, the frequency is locked out of both banks.



## Restore a Locked Out Frequency

1. Select the frequency bank. 
2. Press  to enter Manual Mode. 
3. Press  or  to find the desired frequency. Press and hold  or  to scroll rapidly.

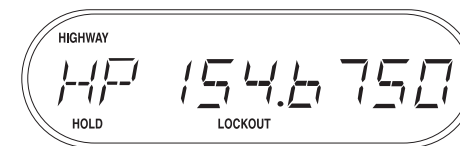
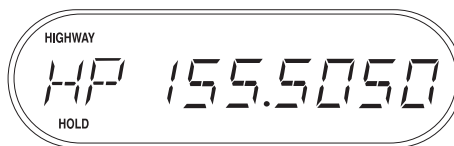
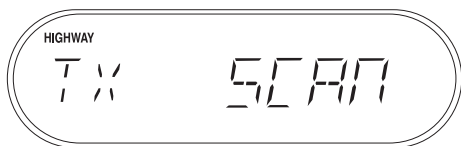

4. Press  to unlock the frequency. 
5. Press  to resume scanning.

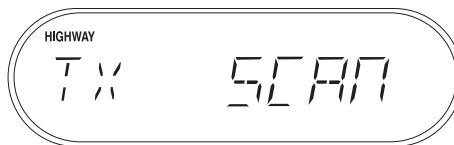
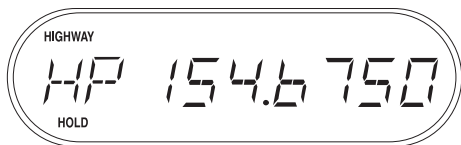

## Restore All Locked-Out Frequencies

Press and hold  for two seconds.



You'll hear two beeps when all frequencies are restored.

OR In the Alert Monitor Frequency Banks, press  to change the state code. Lockout is cleared as soon as scanning starts.

## Search

You can use the SEARCH feature to find active frequencies in your area. Many frequencies have already been pre-programmed into one of the SCAN MODES (Highway, Police, DOT, etc.).



You can search for any frequencies between 29.000 and 956.000 MHz, as well as CB channels 1 through 40, as long as they are within the 12 Bands covered by the **BCT7**. See the table on page 5, or the Specifications at the back of this Guide.

1. Press **BAND** to enter Band Search Mode.



2. Two seconds later, the **BCT7** begins searching that band.



Press  or  to change the direction (up or down) of the frequency search.



OR

Press **BAND** repeatedly to select another band.

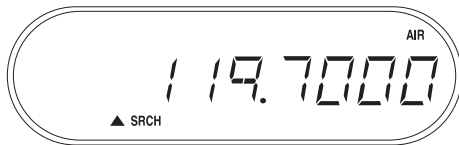





During Search, press **LOCKOUT** to lockout undesired frequencies that the scanner stops on.

**Note:** *AIR* appears when searching the Aircraft Band.

## CB Channel Search

The 40 Citizen's Band (CB) channels comprise one of the 12 search bands available in the **BCT7**.

1. Press  repeatedly until the CB band is active 
2. After 2 seconds, the search begins through the 40 CB channels. Press  or  to change the channel search direction. 
3. When the **BCT7** finds CB communications, the CB channel and frequency displays.

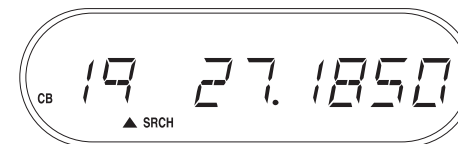
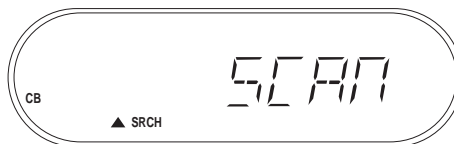
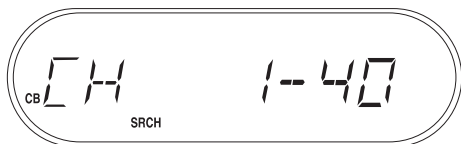

### Notes:

In the SEARCH function, you can turn the Data Skip feature on and off. (See "Data Skip," page 20.)

For easy access to the CB search, do not change the search band from CB. Each time you access band search, the radio will begin searching in the CB channels automatically.

---

## Hold/Resume While Searching

- Press  to stop the search on any frequency of interest.  Press  to resume searching.



## Data Skip

Your **BCT7** automatically skips certain data channels which broadcast non-voice communications (primarily pagers). An icon in the display shows when Data Skip is on. This feature works in all modes except CB, AIR and Weather.

To turn Data Skip OFF or ON:

1. Press  key repeatedly until **SKIP** appears.



2. Press  within two seconds to turn Data Skip off (or on). The data icon appears in the display.



## Programming

Your **BCT7** contains 100 programmable memory channels available in the following frequency banks:

<b>Highway</b>	25 programmable channels (+ pre-programmed channels)
<b>Police</b>	25 programmable channels (+ pre-programmed channels)
<b>DOT</b>	10 programmable channels (+ pre-programmed channels)
<b>News</b>	5 programmable channels (+ pre-programmed channels)
<b>Fire</b>	10 programmable channels (+ pre-programmed channels)
<b>Private</b>	25 programmable channels ONLY

You can add frequencies to the pre-programmed frequency banks, and create your own bank of up to 25 channels in the PRIVATE frequency bank.

**Note:** Before programming, check the back of the unit and make sure the MEMOLOCK switch is set to OFF. (See “Memory Lock,” page 24.)

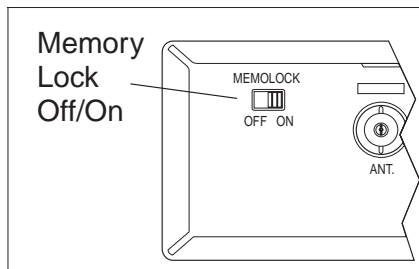

## Programming Frequencies

1. Press **BAND** to find a frequency band you wish to search.

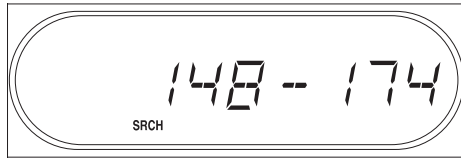

2. When the **BCT7** begins searching, press **◉**.



3. Press **▲** or **▼** to find the desired frequency.



4. Press **PROG**.



5. Select the bank where you want to program the frequency (Highway, Police, DOT, News, Fire or Private). The unprogrammed channel number and 000.0000 flash on and off over the frequency you chose.



6. Press **▲** or **▼** keys to move to the channel where you wish to program the frequency (you may skip this step if you wish to simply place the frequency in the next available channel).



7. Press **PROG** again to enter the frequency.



8. Press **◉** to begin scanning

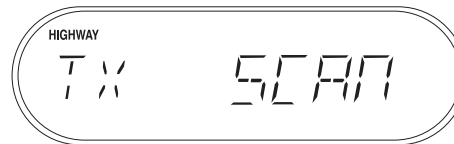

OR

9. Press the **BAND** key to begin selecting another frequency to program.

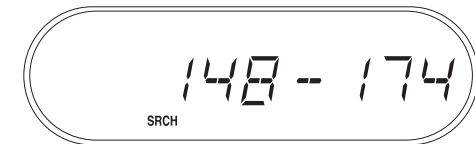

If you find a frequency you would like to program while in a general search of a band, press **◉** to stop the search on the frequency, then follow programming steps 3 through 8.

## Clearing a User-Programmed Frequency

To erase a user-programmed frequency:

1. Press **BAND**.



2. Press **⊙** twice to start search and hold on any frequency.



3. Press **PROG**.

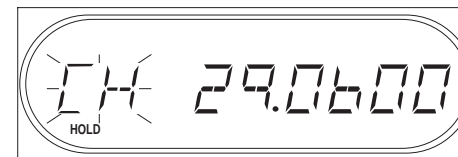
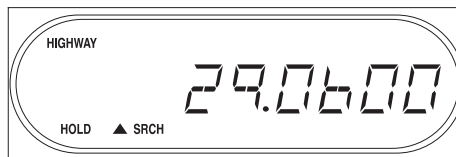
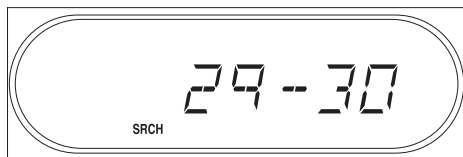

4. Press and hold **▼** until 000.0000 appears in the display.



5. Press the frequency bank key desired (**HIGHWAY**, **POL/DOT**, etc.)



6. Press **▲** or **▼** to select the Channel you want to clear.

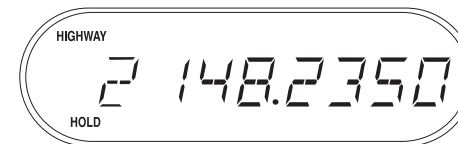

7. Press **PROG** to program 000.0000 into memory.



## Memory Lock

To avoid accidental programming of your **BCT7** after you have programmed all the frequencies to your satisfaction, slide the MEMOLOCK switch on the back panel of the radio to ON.

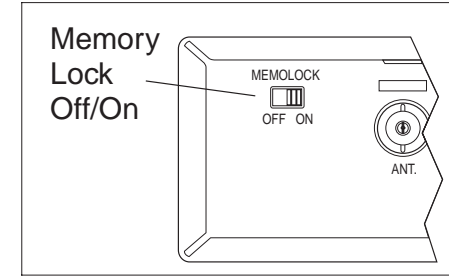

If you attempt to enter frequencies after you have locked the program, the display will show PRG-LOC. Slide the switch back to OFF to enter frequencies once again.



## Memory Back-up

Your **BCT7** has a memory back-up system that remembers your frequency selections and deletions when you turn off the unit. This memory lasts approximately 30 days without any external power to the unit.



## Mobile Installation

Before starting installation, select a location for the radio bracket that is convenient for operation and **does not** interfere with the driver or passenger in the vehicle.

1. Secure the bracket to a solid surface using the self tapping screws provided.
2. Mount the scanner to the bracket with the thumb screws.
3. Adjust the angle of the radio.

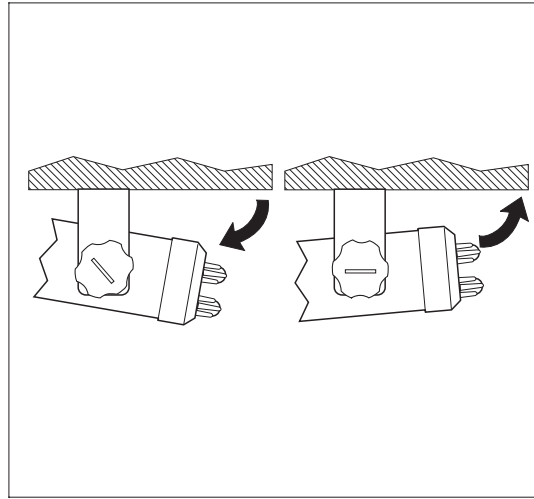
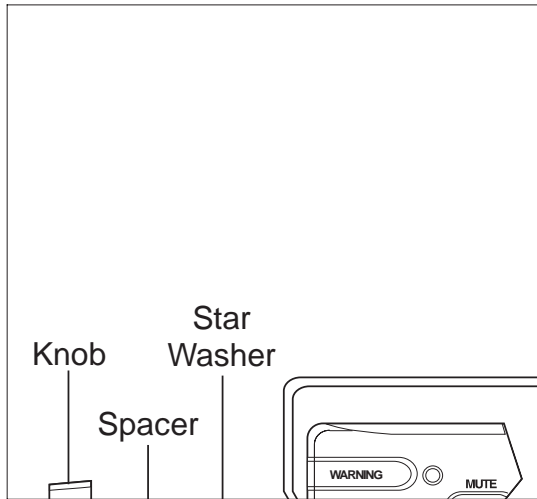

## Connecting the Power

The **BCT7** is designed to be used in any vehicle which has a 12-volt DC negative ground electrical system. If you cannot determine the polarity of your vehicle, consult your vehicle dealer for information.

1. Connect the **BCT7** power cord directly to the fuse block or battery of your car.

- OR -

Plug one end of the cigarette lighter power cord into your vehicle's cigarette lighter.

2. Connect the power cord to the jack marked "DC 13.8V" on the back of the radio.
3. Attach the external antenna connector to the jack marked "ANT."

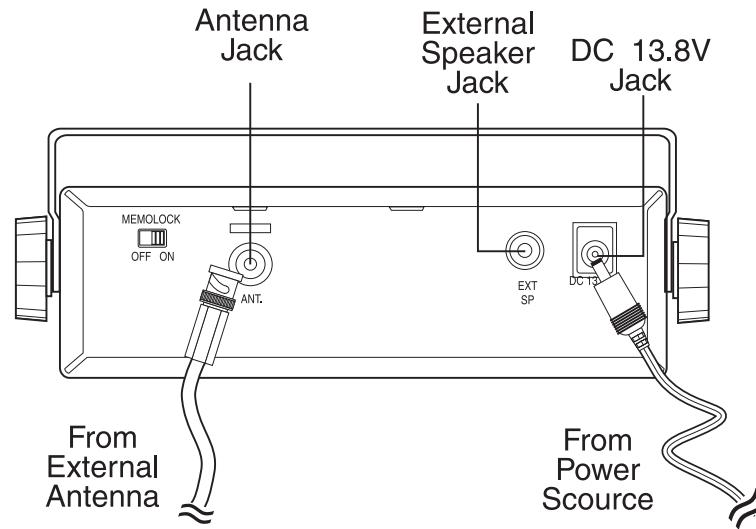

**Note:** The power cord provided with your **BCT7** contains a 1-amp fuse. Whenever necessary, replace it only with the same type of fuse.

Uniden recommends using an external antenna designed specifically for scanning radios.

**Do not use the telescoping antenna in a mobile installation.**

## Base Installation

In addition to mobile installation, you can operate the **BCT7** as a base unit with the included AC Adapter and Telescoping Antenna.

**Note:** Use only the AC Adapter supplied with this unit.

1. Plug the telescoping antenna into the antenna jack on the rear of the unit.
2. Plug the AC Adapter into the jack marked "DC 13.8V."
3. Plug the adapter into a 120V AC 60 Hz wall outlet.

Operation of the scanner is the same as for mobile use.

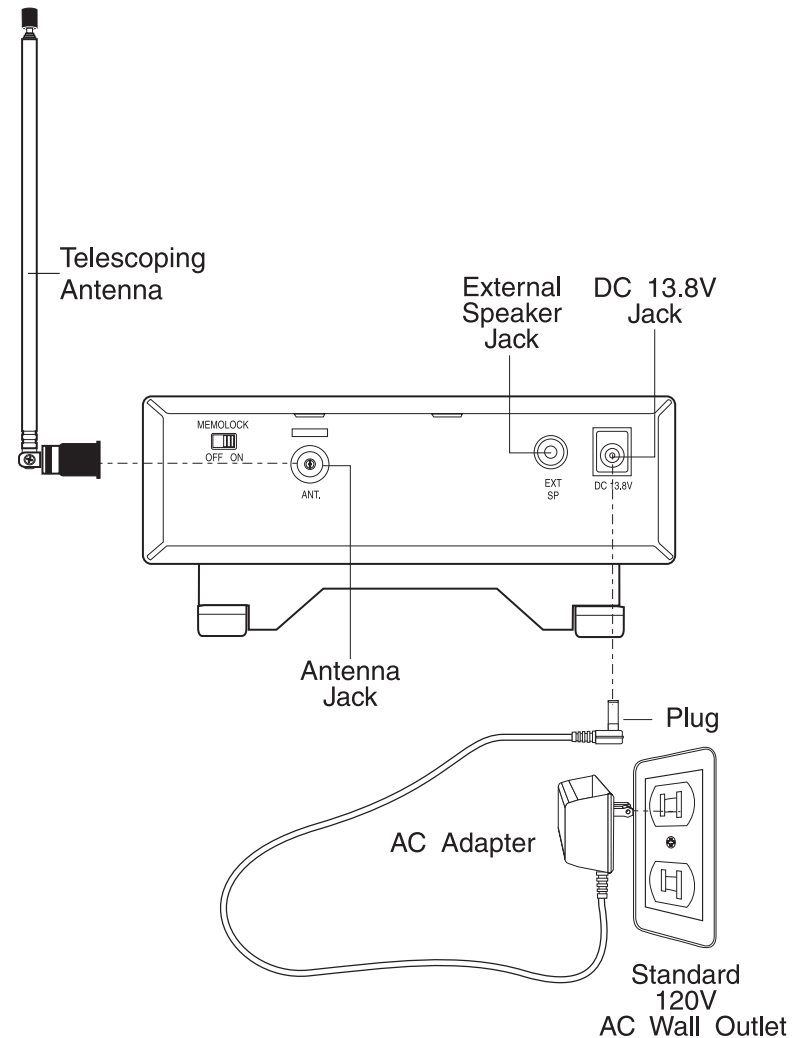

---

---

## Tips & Techniques

---

---

Leave the Band Search set for CB (CB follows 806-956 MHz and precedes 29-30 MHz). This way, whenever you wish to monitor CB radio traffic, you simply press the BAND button once.

Another suggestion for highway driving would be to program CB channel 19 into one of the available HIGHWAY programmable channels in the **BCT7**. Truckers and other motorists also use other CB frequencies (such as 11 at times) for highway communications, but 19 is the most common channel. With Channel 19 always at the ready in your HIGHWAY setting, you'll be sure to hear of accidents, traffic jams and other highway dangers well before you come upon them. Remember, though, that CB channels can be quite congested and they may tend to tie-up the **BCT7** with unwanted conversation. On the open interstates, however, it should prove invaluable.

**IMPORTANT!** If you have a CB transmitter in your vehicle, do not program a CB channel into the **BCT7** unless you're sure you won't be transmitting on that channel (or even an adjacent channel).

Otherwise, you'll receive loud feedback through the **BCT7**'s speaker.

The Band Search feature also breaks down the bands into amateur radio "Ham" frequency bands which are very valuable during severe weather or for road condition and traffic information. Ham operators provide emergency communications for agencies such as the Red Cross and state civil preparedness, during tornado, hurricane or blizzard season. During morning or evening rush hours, hams will provide information on traffic as they ride to or from work. Ham channels can become congested with long conversations, however, and you may not wish to tie-up your **BCT7** with these frequencies.

For indoor use, extend the telescoping antenna to its full height. For UHF frequencies, shortening the antenna may improve the reception.

If your scanner receives strong interference or electrical noise, move the scanner or its antenna away from the source.

If you are operating the scanner in a fringe area or need to improve reception, use an optional antenna designed for multi-band coverage. (You can purchase this type of antenna at a local electronics store.)

If the plug at the end of the cable does not match the antenna jack, you may need to purchase an adapter.

## Trunking

A few state Highway Patrol agencies, and many local and county public safety services, utilize a new type of transmission scheme known as trunking. Trunking allows a number of agencies (such as city police, fire, highway and sewer departments), and/or a number of divisions within an agency (police patrol, detectives, radar teams, warrant servers...), to operate on a single radio system without interference from one another. The agencies may share a three to twenty or more channel radio system in which particular divisions hop about the assigned frequencies as they become available.

A dispatcher may be communicating with a precinct's patrol units on 856.7125 one moment, and then receive a reply from a patrol car 30 seconds later on 858.4875. In the meantime, 856.7125 will have been used by two sewer workers. It all happens transparently to the radio users. To them they're the only people using the system and they never have to change channels. To the scanner user, however, it becomes a challenge to follow a conversation. All a scanner user can do is either wait for the radio to resume scanning to the next frequency or use  to move off of an uninteresting conversation.

To complicate matters, trunking radios are computer controlled. To effect the computer operation, data bursts and tones are broadcast over trunking frequencies. In the most common type of trunking system, a data frequency is selected for a 12 or 24 hour period. Scanner users are advised to LOCKOUT this frequency (so that the scanner doesn't stop each time it scans by the channel). The next time you turn the scanner on, another frequency, in the same system, may be used as the data channel. You will want to lockout this new data frequency but you must remember to unlock the old frequency which will now be used for voice transmissions.

## **Scanner Care & Maintenance Tips**

- Do not use the scanner in high-moisture areas such as the kitchen or bathroom.
- Do not plug the scanner into an outlet controlled by a wall switch as prolonged periods without power causes scanner memory loss.
- Avoid placing the unit in direct sunlight or near heating elements or vents.

---

---

# Troubleshooting

---

---

If your **BCT7** is not performing properly, try the steps listed below.

PROBLEM	SUGGESTION
Scanner is not giving Warning Alerts.	Check to see if Mute and Flash are both turned off. The Squelch threshold may be set too high. Check antenna connections. Some priority frequencies may be locked out. Make sure the frequency bank you're scanning is an Alert Frequency Bank (Highway, Police, DOT).
Scanner is not working properly.	Check power cord and in-line fuse. Check the Volume and Squelch settings.
Signal is weak or distorted.	Check antenna and antenna connection, or change antenna.
Improper reception.	Check antenna and antenna connection, or change antenna. Reposition scanner.
Scan won't stop.	Check Squelch adjustment. Check antenna and antenna connection, or change antenna.
Incomplete reception.	Fringe area of reception. Check Squelch adjustment.
Weather Search (WX) won't work.	Check Squelch adjustment. No active station within range.
Radio transmissions (conversations) are cutting in and out.	The PRIORITY system is checking for alarms. Use the  button to hold on a frequency without check of priority channels every two seconds.

<p>Going by patrol cars and not receiving alarms.</p>	<p>Make sure you are scanning one of the Warning Alert Frequency Banks - Highway, Police, or DOT.  Check antenna connections.  Conditions to activate the alarm are variable and depend upon the timing of the dispatcher transmissions and proximity of patrol car to your vehicle. Also, terrain and other factors may be involved.  Officer has the ability to turn off the mobile extender when off-duty, or when going to court, etc., but will normally leave extender operating when on traffic duty.  If you're monitoring user-programmed frequencies, switch to one of the preprogrammed frequency banks.</p>
<p>The radio keeps locking-up on frequencies filled with strange noises or transmissions (aircraft communications, weather, etc.)</p>	<p>Sometimes, in a heavily congested area with a lot of radio transmitters (an urban area or an area where TV/ radio towers are located), this always occurs. Try turning your squelch down or locking out the offending frequencies.</p>

If you still cannot get satisfactory results, call the Uniden Customer Service Center at 1-800-297-1023, 8 a.m. to 5 p.m. Central, Monday through Friday.



# Optional Accessories and Replacement Parts

Operating Guide  
(OMBCT7)



Betty Bearcat  
Starter Frequency  
Guide



Hard Wire Cord  
(PS001)

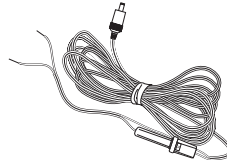

Flexible Mobile Antenna  
(ANT002)

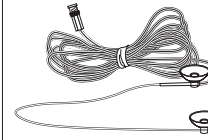

Cigarette Lighter  
Adapter Plug  
(WZ-1244)

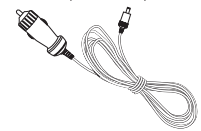

Mobile Mounting Bracket  
Assembly Kit  
(MB007)

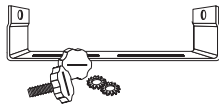

Telescoping Antenna  
(AT124)

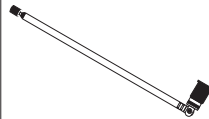

AC Adapter  
(AD140U)

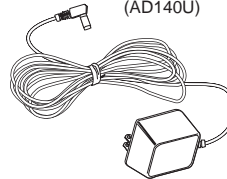

External Speaker  
(ESP25, 8Ω)

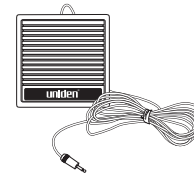

---

---

# SPECIFICATIONS

---

---

**Receiver Type:** Triple Conversion Superheterodyne  
**Banks:** Total 7 banks: 6 Service banks and 1 programmable bank  
**HIGHWAY PATROL** 1,142 programmed plus 25 programmable channels  
**POLICE:** 5,185 programmed plus 25 programmable channels  
**DOT:** 459 programmed plus 10 programmable channels  
**FIRE** 160 programmed plus 10 programmable channels  
**NEWS:** 178 programmed plus 5 programmable channels  
**WX:** 9 programmed. (7 NOAA weather service,  
2 Canadian Coast Guard)  
**PRIVATE:** 25 channels fully user programmable  
(Total 100 programmable channels)

**Scan Rate:** Up to 100 channels per second.  
**Scan Delay:** 2 seconds  
**Audio Output:** Max 3W  
**Antenna:** 50 ohms (Impedance)  
**Operating Temperature:** - 20°C (- 4°F) to + 60°C (+ 140°F)  
**Size:** 5-1/5" (W) x 6-15/16" (D) x 1-5/8" (H)  
**Weight:** 1 lb 11oz.

**Search Band:** Total 12 Search bands: (All NFM except aircraft and CB bands)

Display	Frequency Coverage	Steps
29 - 30	29.000 to 30.000 MHz	5 kHz
30 - 50	0.000 to 50.000 MHz	5 kHz
118 - 137	118.000 to 136.975 MHz (AM)	12.5 kHz
137 - 144	137.000 to 144.000 MHz	5 kHz
144 - 148	144.000 to 148.000 MHz	5 kHz
148 - 174	148.000 to 174.000 MHz	5 kHz
406 - 420	406.000 to 420.000 MHz	12.5 kHz
420 - 450	420.000 to 450.000 MHz	12.5 kHz
450 - 470	450.000 to 470.000 MHz	12.5 kHz
470 - 512	470.000 to 512.000 MHz	12.5 kHz
806-956	806.0000 to 823.9875 MHz	12.5 kHz
	849.1125 to 868.9875 MHz	12.5 kHz
	894.1125 to 956.0000 MHz	12.5 kHz
CH 1 - 40	26.9650 MHz - 27.4050 MHz(AM)	10 kHz

Certified in accordance with FCC Rules and Regulations Part 15 Sub-part C as of date of manufacture.  
Features, specifications, and availability of optional accessories are all subject to change without notice.

**uniden**  
**Bearcat**

BearTracker 800 🐾

**BCT 7**

Highway Communications  
System & Preprogrammed  
Warning Scanner

UBUD01250ZZ



**OPERATING GUIDE**

# Precautions

Before you use this scanner, please observe the following:

---

## WARNING!

Uniden America Corporation does not represent this unit to be waterproof. To reduce the risk of fire, electrical shock, or damage to the unit, do not expose this unit to rain or moisture.

---

## IMPORTANT!

The installation, possession, or use of this scanning radio in a motor vehicle may be prohibited, regulated, or require a permit in certain states, cities, and/or local jurisdiction. Your local law enforcement officials should be able to provide you with information regarding the laws in your community.

Changes or modifications to this product not expressly approved by Uniden, or operation of this product in any way other than as detailed by this Operating Guide, could void your authority to operate this product.

Covered under one or more of the following patents: RE 31,523 4,027,251 4,057,760 4,092,594 4,100,497 4,114,103 4,123,715 4,156,193 4,157,505 4,179,662 4,219,821 4,270,217 4,398,304 4,409,688 4,455,679 4,461,036 4,521,915 4,587,104 4,627,100 4,481,302 4,888,815 4,932,074 4,947,456 5,014,348 5,199,109
--

*Uniden<sup>®</sup> and Bearcat<sup>®</sup> are registered trademarks of Uniden America Corporation.*

# BCT7 Controls

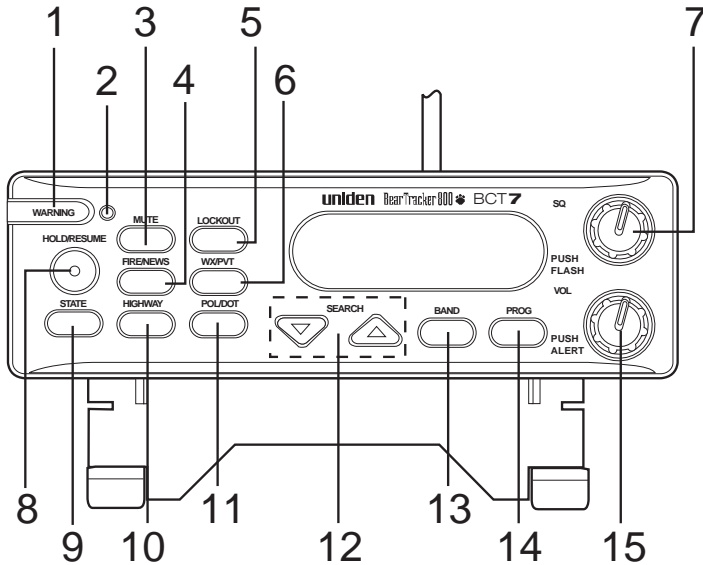

1. Alert Light
2. Mute LED
3. Mute Key
4. Fire/News Frequency Key
5. Lockout Key
6. Weather/Private Frequencies Key
7. Squelch Control/Flash Brightness Selector
8. Hold/Scan Resume Key
9. State Selector Key
10. Highway Frequencies Key
11. Police/D.O.T. Frequencies Key
12. Search Direction Keys
13. Search Band Selector Key
14. Program Frequency Key
15. ON-OFF-Volume Control/Alert Tone Selector

# BCT7 Liquid Crystal Display

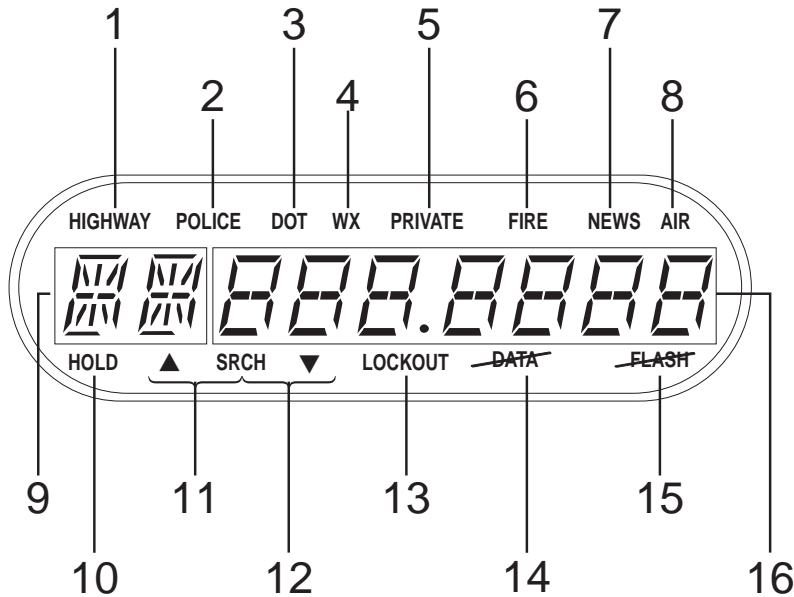

1. Highway Patrol Frequencies
2. Police Frequencies
3. Department of Transportation Frequencies
4. NOAA Weather Frequencies
5. Private Frequencies
6. Fire Frequencies
7. News Frequencies
8. Aircraft Frequencies
9. State/Active Frequency Bank/Channel Indicator
10. Scan Hold Indicator
11. Search Up Indicator
12. Search Down Indicator
13. Frequency Lockout Indicator
14. Data Skip ON Indicator
15. Warning Flash OFF Indicator
16. Frequency Display

---

---

# One Year Limited Warranty

---

---

**Important:** *Evidence of original purchase is required for warranty service.*

**WARRANTOR:** UNIDEN AMERICA CORPORATION (“Uniden”)

**ELEMENTS OF WARRANTY:** Uniden warrants, for one year, to the original retail owner, this Uniden Product to be free from defects in materials and craftsmanship with only the limitations or exclusions set out below.

**WARRANTY DURATION:** This warranty to the original user shall terminate and be of no further effect 12 months after the date of original retail sale. The warranty is invalid if the Product is (A) damaged or not maintained as reasonable or necessary, (B) modified, altered, or used as part of any conversion kits, sub- assemblies, or any configurations not sold by Uniden, (C) improperly installed, (D) serviced or repaired by someone other than an authorized Uniden service center for a defect or malfunction covered by this warranty, (E) used in any conjunction with equipment or parts or as part of any system not manufactured by Uniden, or (F) installed, programmed, by anyone other than as detailed by the operating guide for this product.

**STATEMENT OF REMEDY:** In the event that the product does not conform to this warranty at any time while this warranty is in effect, warrantor will repair the defect and return it to you without charge for parts, service, or any other cost (except shipping and handling) incurred by warrantor or its representatives in connection with the performance of this warranty. THE LIMITED WARRANTY SET FORTH ABOVE IS THE SOLE AND ENTIRE WARRANTY PERTAINING TO THE PRODUCT AND IS IN LIEU OF AND EXCLUDES ALL OTHER WARRANTIES OF ANY NATURE WHATSOEVER, WHETHER EXPRESS, IMPLIED OR ARISING BY OPERATION OF LAW, INCLUDING, BUT NOT LIMITED TO ANY IMPLIED WARRANTIES OF MERCHANTABILITY OR FITNESS FOR A PARTICULAR PURPOSE. THIS WARRANTY DOES NOT COVER OR PROVIDE FOR THE REIMBURSEMENT OR PAYMENT OF INCIDENTAL OR CONSEQUENTIAL DAMAGES. Some states do not allow this exclusion or limitation of incidental or consequential damages so the above limitation or exclusion may not apply to you.

**LEGAL REMEDIES:** This warranty gives you specific legal rights, and you may also have other rights which vary from state to state. This warranty is void outside the United States of America.

**PROCEDURE FOR OBTAINING PERFORMANCE OF WARRANTY:** If, after following the instructions in this Operating Guide you are certain that the Product is defective, pack the Product carefully (preferably in its original packaging). The Product should include all parts and accessories originally packaged with the Product. Include evidence of original purchase and a note describing the defect that has caused you to return it, The Product should be shipped or delivered freight prepaid by traceable means, or delivered to warrantor at:

**Uniden America Corporation**

Parts and Service

4700 Amon Carter Blvd.

Ft. Worth, TX 76155

(800)-297-1023, 8 a.m. to 5 p.m., Central, Monday through Friday

Uniden offers 30 days of toll free support and you can call (800) 297-1023, 8 a.m. to 5 p.m. Central, Monday through Friday. Beyond that period, you can obtain assistance by calling (900) 224-4UAC.